







# MUJI

## ALUMINUM LOW TABLE WAGON (LARGE/SMALL)

### Assembly Instructions

- Thank you for purchasing MUJI products.
- Please read carefully before using/assembling this product.
- Please keep these instructions.

#### Parts List

	16
	4
	4
	4
	1
	1

\* 2 out of 4 casters have the stopper.

1. Match the leg hole and the top board hole as shown in the diagram.
2. For the top board, connect the top board and the leg with part C and bolt A. For the lower board, connect the lower board and the leg with the part B and the bolt A.
3. Tuck the caster D into part B and fix them with the spanner F.
4. Use the caster with stopper to stabilize the table wagon by locking.



- \* Unlock the caster stopper to move the table to avoid falling and floor damage.
- \* Do not stand/sit on the table.
- \* Maximum load limit : 88lb.
- \* Do not use product as a cart.

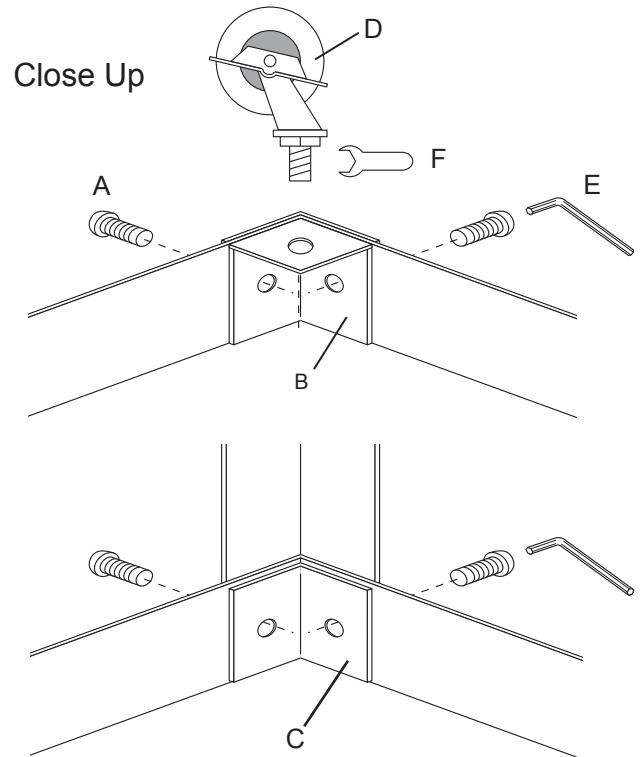
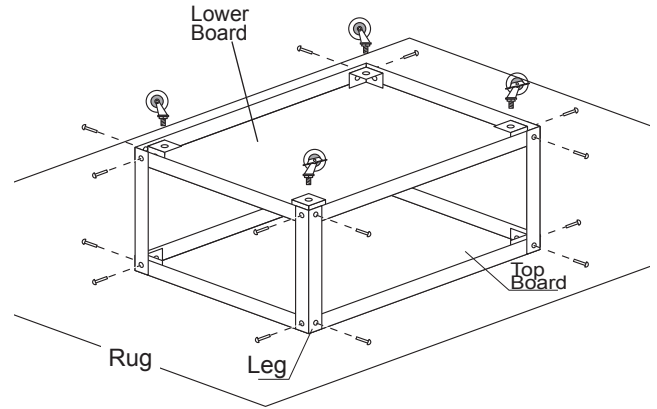

#### Completion Picture

